

# 8|ACOUSTICS

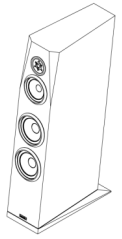

Sasandu | User Manual



### Technical Specifications :

Frequency range	: 32-32000 Hz +3/-6 dB
Sensitivity (2.83V / 1m)	: 89 dB
Nominal impedance	: 4Ω
Max SPL	: 108 dB
Recommended amplifier	: 100-200 W
Cross-over frequencies	: 480 Hz & 2800 Hz
Speaker type	: 3-way Floor Stand
Enclosure type	: Bass reflex (woofers), sealed (midrange)
Port tuning frequency	: 32 Hz

### Drive Units:

- High frequency driver	SATORI TW29BN-B-8 or TW29BN-8 (29 mm beryllium dome)
- Mid frequency driver	6.5" SATORI MR16P-4 or MR16PNW-4 (advanced midrange)
- Low frequency drivers	2 x 7.5" SATORI MW19P-8 or MW19PNW-8 (advanced midwoofer)

### Cabinet:

15mm, 18mm, 25 mm MDF	
Dimensions (H x W x D)	: 1100 x 230 x 615 mm / 43.30 x 9.05 x 24.21 inch
Port dimensions (inside)	: Ø75 x 150 mm (Ø3" x 6.1")

### Net Weight (pair):

- Cabinet only	: 28.5 kg / 62.83 lb
- Full assembly	: 32.5 kg / 71.65 lb

### Special Features:

- Advanced high-end drivers.
- Non-parallel cabinet walls.
- Facets and optimized tweeter position for reduced diffraction.
- Slanted internal partition for reduction of standing waves.
- Inclined baffle for time alignment of drivers.
- Large low compression midrange cavity.
- Large low noise vent.
- Strategic internal bracing and damping.
- Solid single-wiring binding posts.

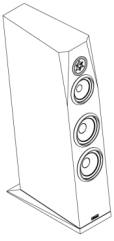

### Frequency Response

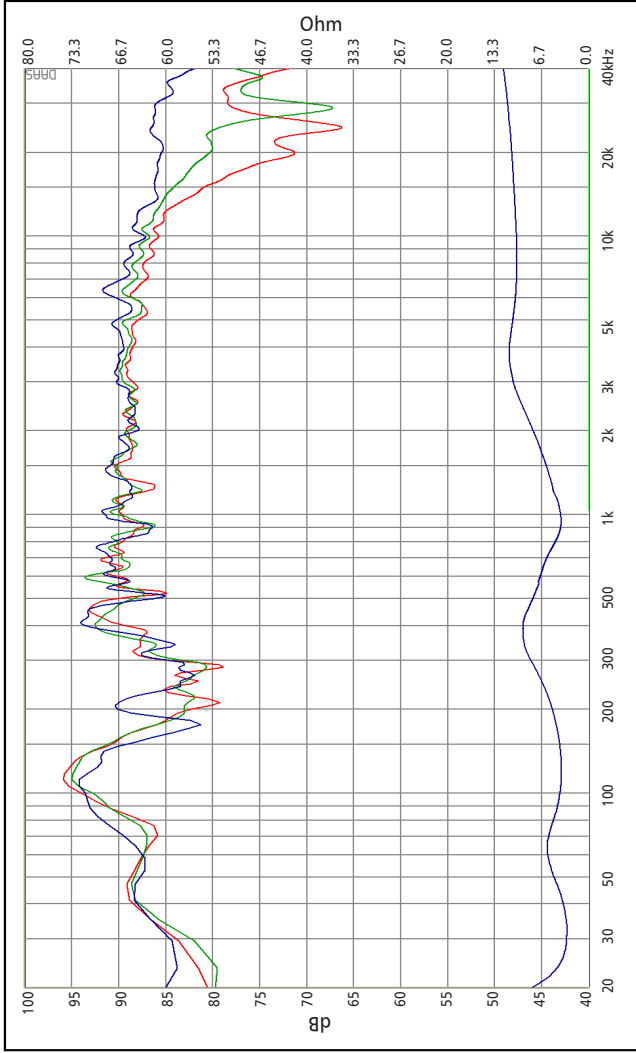

Response Curve :  
— (Blue) : on axis  
— (Green) : 15° off-axis  
— (Red) : 30° off-axis

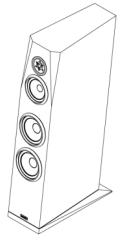

### Mechanical Drawing (dimensions in mm)

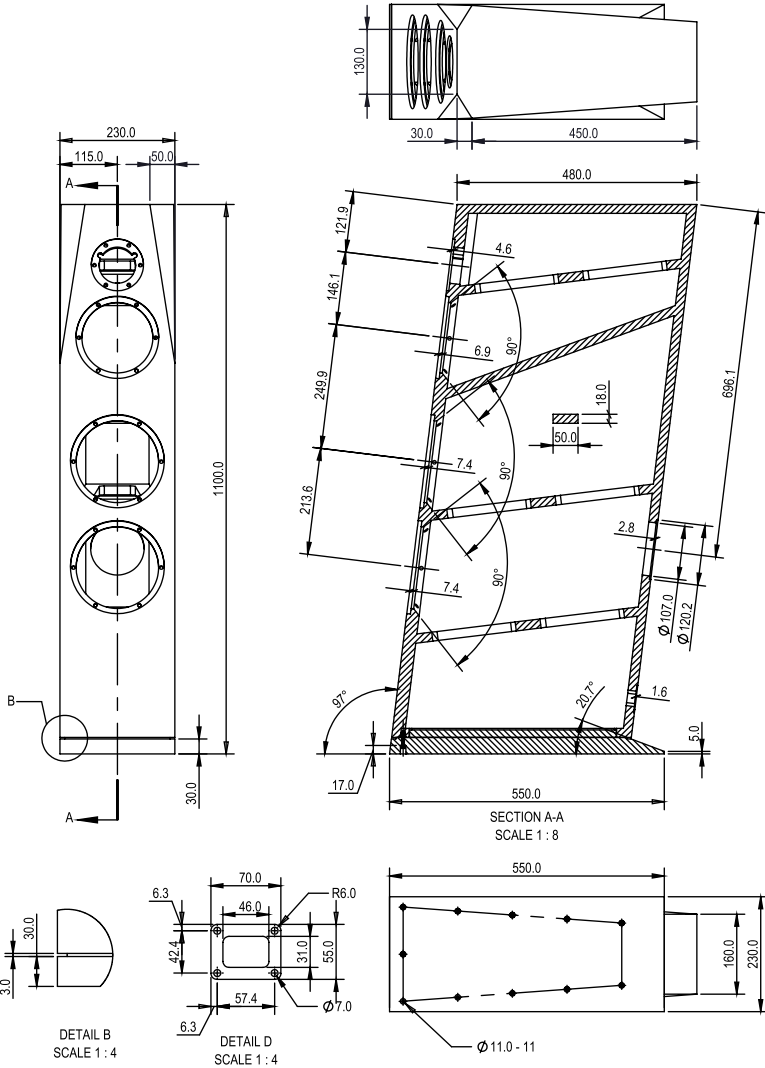

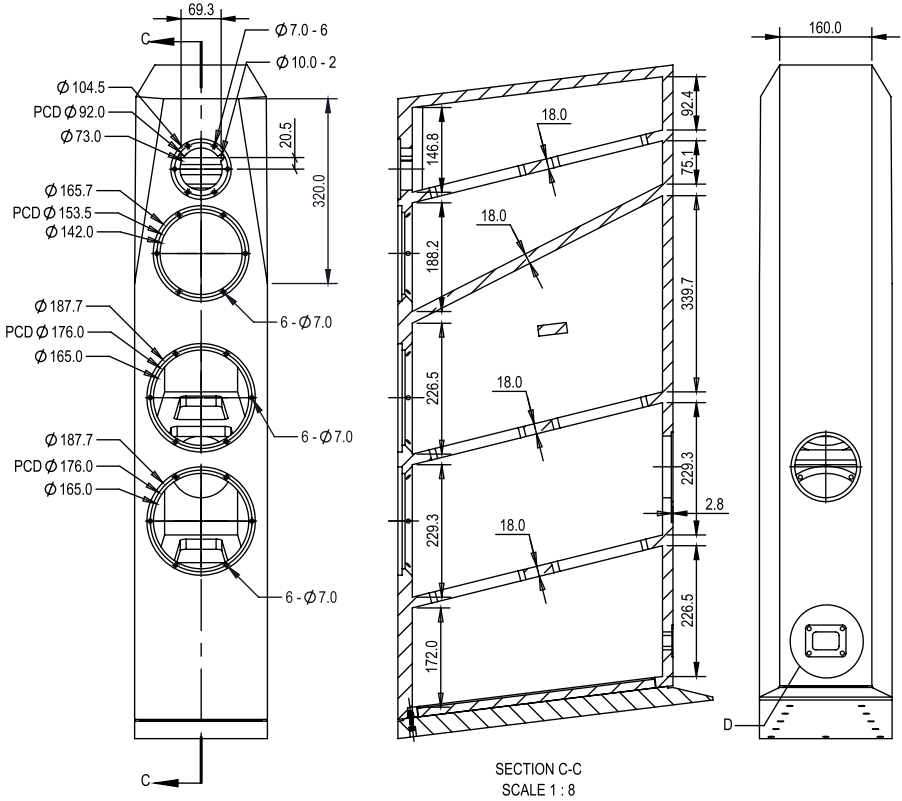
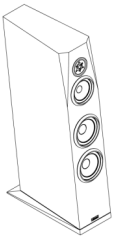

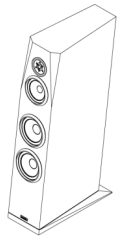

## SASANDU - EXPLODED VIEW

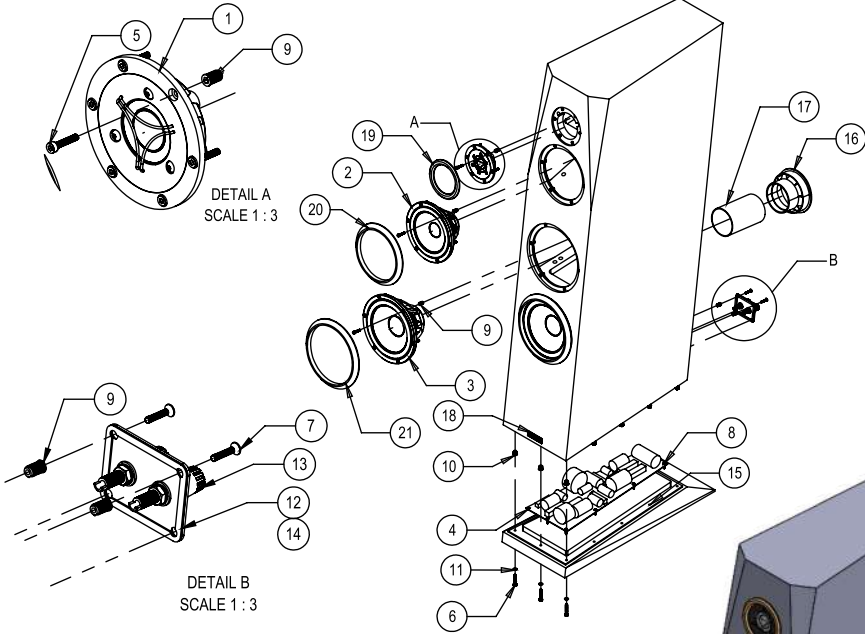

NO	PART NAME	QTY
1	HF driver Satori TW29BN-B-8 or TW29BN-8 (sold separately)	1
2	MF driver Satori MR16P-4 or MR16PNW-4 (sold separately)	1
3	LF drivers Satori MW19P-8 or MW19PNW-8 (sold separately)	2
4	Sasandu kit crossover (sold separately)	1
5	Hex socket screw M4 x 20mm (for drivers)	24
6	Hex socket screw M5 x 30mm (for pedestal)	11
7	Countersunk screw M4 x 20mm (for terminal plate)	4
8	Wood screw 4 x 16 mm for crossover (from crossover kit)	10
9	Insert nut M4 (installed)	28
10	Insert nut M5 (installed)	11
11	Washer Plate	11
12	Stainless Terminal plate	1
13	Binding post	1
14	Seal gasket (for terminal plate)	1
15	Seal gasket (for pedestal, installed on cabinet)	1
16	Port flare (installed on cabinet)	1
17	Port paper tube (installed on cabinet)	1
18	Name plate	1
19	Tweeter grille	1
20	Midrange grille	1
21	Woofer grille	2

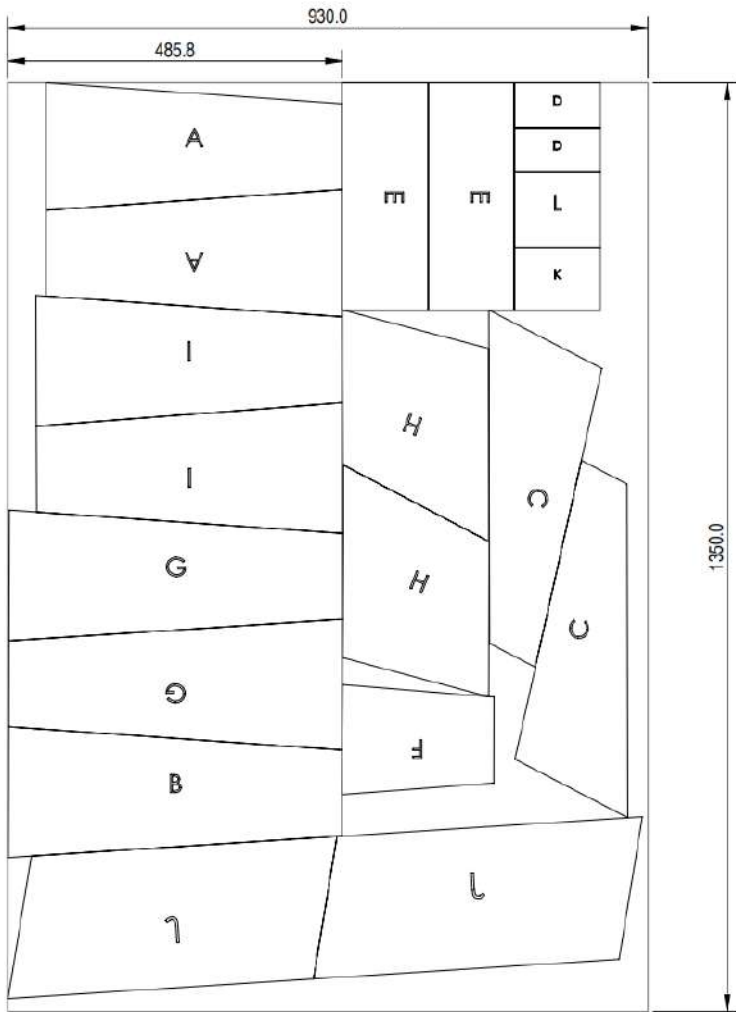
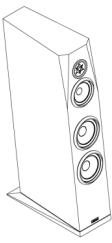

NO.	PART NUMBER	DESCRIPTION	QTY.
1	A	DA-DACRON-(430x125x430x185)mm	2
2	B	DA-DACRON-(485x125x485x190)mm	1
3	C	DA-DACRON-(445x185x485x75)mm	2
4	D	DA-DACRON-(65x125)mm	2
5	E	DA-DACRON-(330x125)mm	2
6	F	DA-DACRON-(220x125x220x160)mm	1
7	G	DA-DACRON-(485x125x485x190)mm	2
8	H	DA-DACRON-(240x225x220x280)mm	2
9	I	DA-DACRON-(445x125x445x190)mm	2
10	J	DA-DACRON-(445x210x445x210)mm	2
11	K	DA-DACRON-(90x125)mm	1
12	L	DA-DACRON-(110x125)mm	1

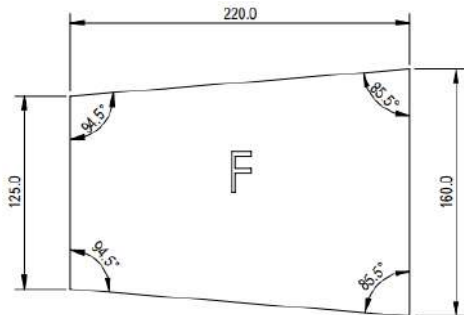
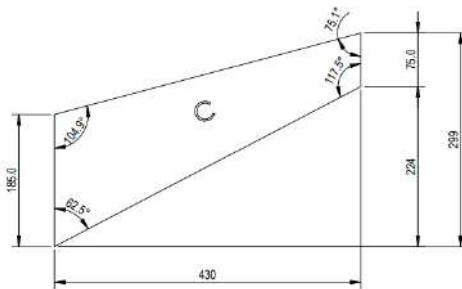
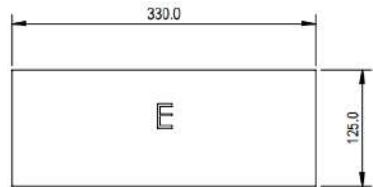
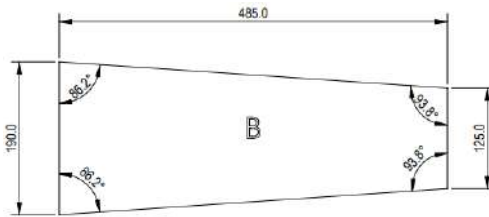
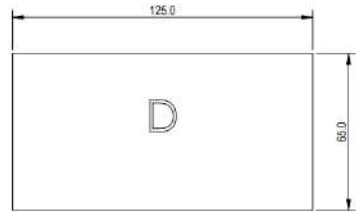
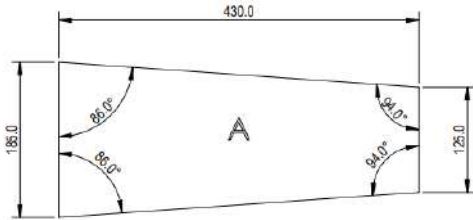
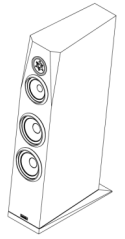

NO.	PART NUMBER	DESCRIPTION	QTY.
1	A	DA-DACRON-(430x125x430x185)mm	2
2	B	DA-DACRON-(485x125x485x190)mm	1
3	C	DA-DACRON-(445x185x485x75)mm	2
4	D	DA-DACRON-(65x125)mm	2
5	E	DA-DACRON-(330x125)mm	2
6	F	DA-DACRON-(220x125x220x160)mm	1



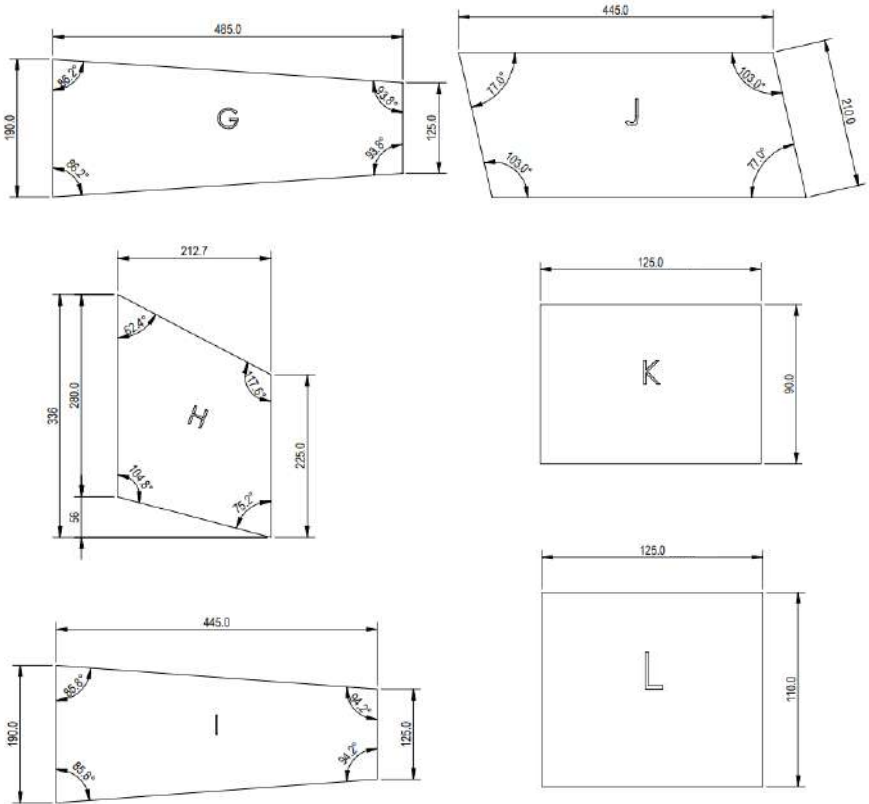
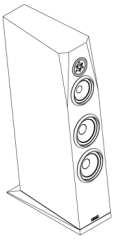

NO.	PART NUMBER	DESCRIPTION	QTY.
7	G	DA-DACRON-(485x125x485x190)mm	2
8	H	DA-DACRON-(240x225x220x280)mm	2
9	I	DA-DACRON-(445x125x445x190)mm	2
10	J	DA-DACRON-(445x210x445x210)mm	2
11	K	DA-DACRON-(90x125)mm	1
12	L	DA-DACRON-(110x125)mm	1

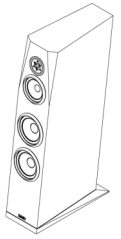

## Damping Material Position (dimensions in mm)

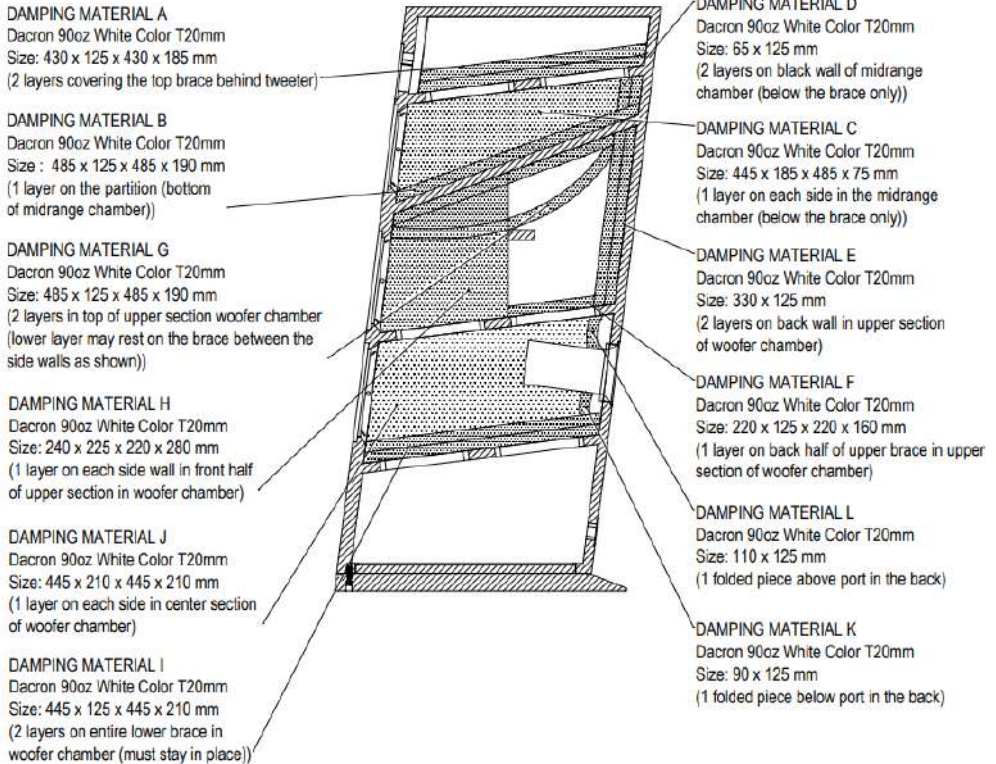

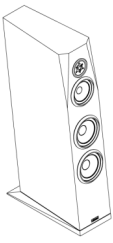

## Crossover Schematic ( Sasandu )

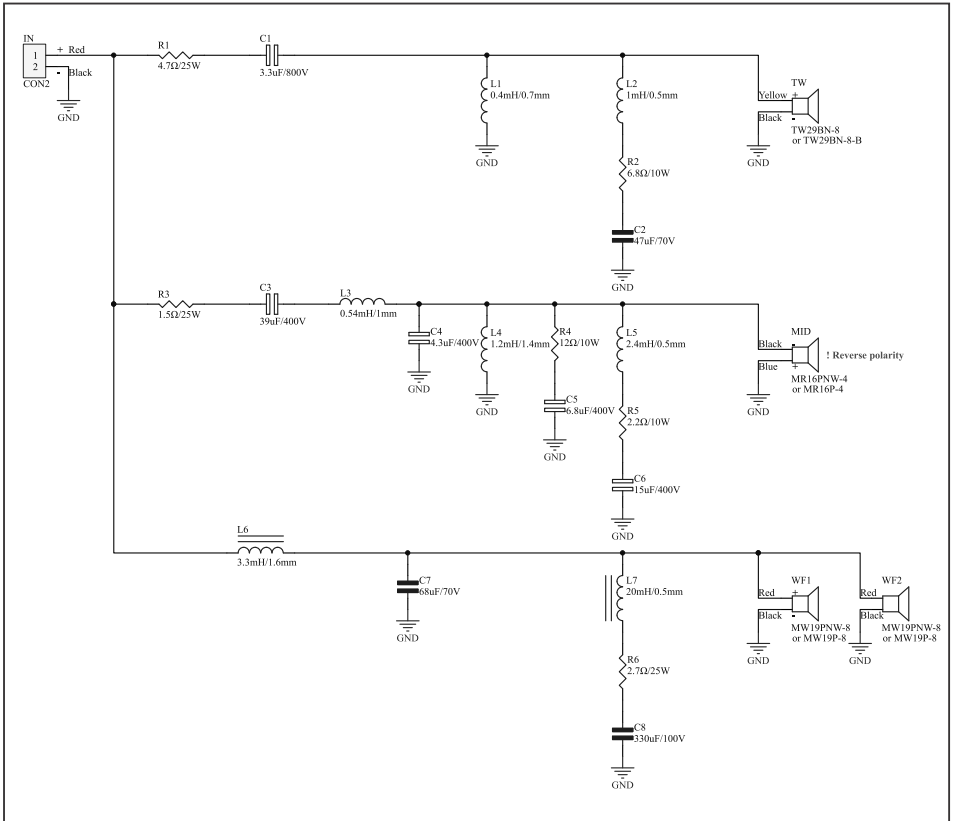

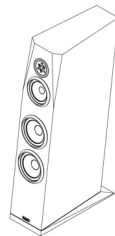

### Part List (each cabinet):

- High frequency driver SATORI TW29BN-B-8 or TW29BN-8 (sold separately) .....	1 pc
- Mid frequency driver 6.5" SATORI MR16P-4 or MR16PNW-4 (sold separately) .....	1 pc
- Low frequency drivers 7.5" SATORI MW19P-8 or MW19PNW-8 (sold separately) .....	2 pcs
- Sasandu crossover kit (sold separately) .....	1 pc
- Hex socket screw M4 x 20mm (for drivers) .....	24 pcs
- Hex socket screw M5 x 30mm (for pedestal) .....	11 pcs
- Countersunk screw M4 x 20mm (for terminal plate) .....	4 pcs
- Wood screw 4 x 16 mm for crossover (from crossover kit) .....	10 pcs
- Insert nut M4 (Installed) .....	28 pcs
- Insert nut M5 (Installed) .....	11 pcs
- Stainless Terminal plate .....	1 pc
- Binding post .....	1 pair
- Seal gasket (for terminal plate) .....	1 pc
- Seal gasket (for pedestal, installed on cabinet) .....	1 pc
- Port flare (installed on cabinet) .....	1 pc
- Port paper tube (installed on cabinet) .....	1 pc
- Damping .....	1 pc
- Name plate .....	1 pc
- Tweeter grille .....	1 pc
- Midrange grille .....	1 pc
- Woofer grille .....	2 pcs

### Tools Needed:

- Hex key 3mm size (for driver screw).
- Hex key 4mm size (for pedestal screw).
- Hex key 2.5mm size (for terminal plate screw).
- Philips screwdriver no. 2 (for crossover screw).
- Hot melt glue gun (for attaching the damping and sealing the wire hole).

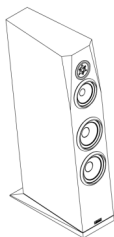

## Assembly Instructions:

1. Carefully remove the cabinet from the packaging. Locate the raw damping material inside the cabinet and set aside.

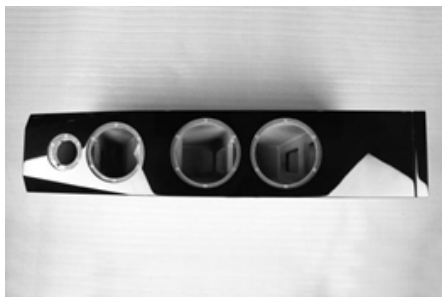

2. Cut the raw damping material into 18 pieces according to the cutting pattern diagram.



3. Place each damping part into the cabinet according to the position diagram. Add a bit of glue if needed to hold the damping in place.



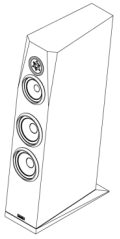

4. Detach the pedestal by loosening the four screws under the speaker cabinet.

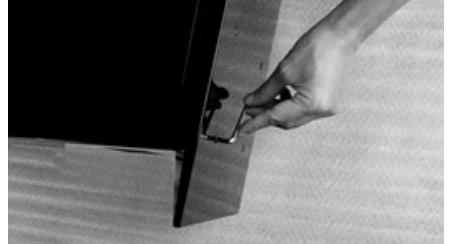

5. Place the crossover onto the top of the pedestal, with the input cables towards the rear terminal side and the speaker wires towards the front panel.



6. Pass the four pairs of speaker wire through the holes in the bottom brace of the cabinet as shown.

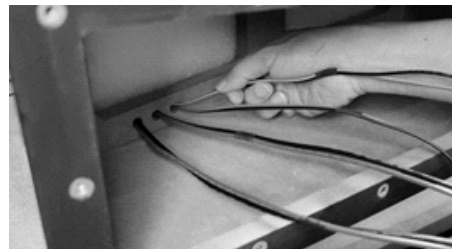

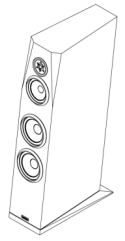

10. Guide the four pairs of cables through the holes in each cabinet bracing.

Pull the tweeter and midrange cables through the midrange chamber partition hole.



11. Seal the cable holes on the midrange chamber partition with hot melt glue.



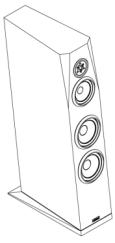

7. Pass the input cable through the terminal hole on the rear of the cabinet, then connect to the binding posts.



8. Mount the terminal panel onto the terminal hole at the back of the cabinet.



9. Mount the pedestal with the crossover to the cabinet. Make sure to gently tighten all 11 screws without over driving.

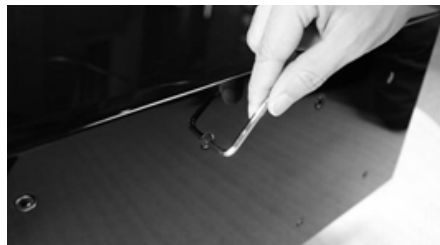



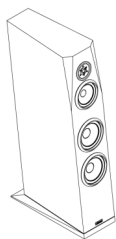

12. Hook up the cables to the woofer, midrange and tweeter terminals.



13. Mount the drivers to the cabinet and gently fasten the screws. Take care not to over tighten.

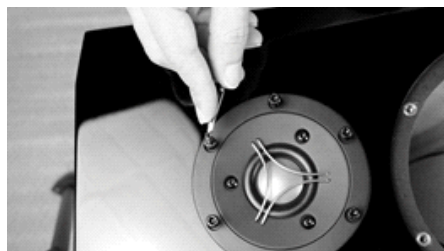

**Find Us On**



[www.sbacoustics.com](http://www.sbacoustics.com)